

K0-1.VIP.V1.4/05.09.2013

DEVICE PURPOSE AND APPLICATION

Emergency Lighting Modules of the VIP... series are designed to be enclosed in electric light fittings which are equipped with fluorescent light sources in the 4-80W range working in either magnetic or electronic ballast circuits. In effect, these electric light fittings are converted to work in the following modes of operation:

- emergency mode with one fluorescent lamp, which turns on only in the case of power supply failure
- supply-network and emergency mode with one lamp. In this mode fluorescent lamp previously working connected to supply network retracts to emergency operation when the network fails
- supply-network and emergency mode with two lamps. In this configuration, in case of power failure one of two previously network connected fluorescent lamps retracts to emergency (battery) operation while the second turns off

WARRANTY

TM Technologie guarantees proper performance of products it manufactures if their operation is conducted within their purpose and with the observance of instructions specified in the manual. Warranty period covers 12 month period after the purchase date. Warranty service is limited to the area of Republic of Poland. In order to ensure flawless performance of the emergency module, interchange of battery packs is required at least every 4 years of operation or in an event of substantial (50%) capacity loss. Any signs of unauthorized opening will result in warranty expiry. Depleted devices ought to be recycled. **Warranty is valid only for products mounted and used on territory of the European Union. Warranty does not cover light sources, battery packs, costs of assembly and disassembly of the devices as well as any other incurred by the client costs related to the claim including trading loss, income loss or loss of profits resulted from lodged complaint. General warranty terms can be found on TM Technologie website www.tmtechnologie.pl**

TECHNICAL DESCRIPTION

Emergency lighting modules are powered by regular alternate current - 230V /50Hz. In the time of normal operation high-temperature Ni-Cd HT battery packs are being charged by supplying current of appropriate characteristics. When voltage drops under critical value or disappears completely automatic switch to emergency operation (battery power) mode is triggered.

Full charging time for the battery is 24 hours (first charging takes 48 hours). Furthermore, converters mounted in the emergency lighting power supply incorporate following systems:

- System of charge control** - prevents batteries from overcharging which has negative effects on the life time of the cells.
- System of discharge control** - prevents batteries from being excessively discharged.
- Automatic switch system** - operates between regular and emergency modes and allows a stable and fluid switch from network supply to emergency supply of the fluorescent light sources.
- LED signalization system** - it consists of LED diode informing about presence of mains voltage and indicating whether there is a proper connection between the converter and the battery and whether the charging process is active.
- Manual test system** - allows manual checks of the casing in an emergency mode of operations.

Emergency modules will work properly only if between their subsequent application battery packs are recharged to a nominal level (which takes 24 hours)

STORAGE AND OPERATING CONDITIONS OF BATTERY PACKS
 Battery packs should be connected to the converter after the circuit of the fluorescent lamp was plugged in. Power should be turned on after all the parts of the system were connected. During storage, assembly and the maintenance-construction works battery pack has to be disconnected from the converter. It is prohibited to continuously drop voltage of the emergency fittings if the battery packs are connected to the converter. Battery pack operational temperature is equal to the operational temperature of the emergency modules i.e. 10 °C to 55 °C for VIP.. ST, ST2, PRO and -15°C to 50 °C for VIP.. COLD

STORAGE CONDITIONS OF BATTERY PACKS
 Air humidity: 85% maximum
 Duration and temperature of storage:

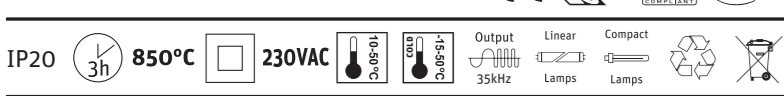
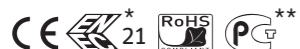

*the models according to the Catalog of TM TECHNOLOGIE **on selected models

2 years* in temp. 0°C to 45°C
 6 months in temp. 0°C to 55°C
 *do not store battery packs for a period of time longer than six months without charging

ASSEMBLY

During the assembly of an emergency module of the fittings in the first class of insulation always connect the protective conductor PE. Do not connect the PE conductors is a gross violation of safety rules. May result in incorrect operation of the module as well as cause damage to the emergency unit or electronic ballast.

FAILURE TO ADHERE TO CONDITIONS LISTED ABOVE MAY RESULT IN DAMAGING THE MODULES, BATTERY PACKS, LIMITING THEIR LIFESPAN AND RELIABILITY OF THEIR OPERATION! THIS IN TURN LEADS TO VOIDING THE PROVIDED WARRANTY ON MODULES!

OPERATION

Attention! First activation
 A discharged battery reaches its full capacity after 24 hours of charging. However, due to technical characteristics of Ni-Cd battery, requirements of proper formatting of this type of battery demand that it should be charged for the first time continuously for 48 hours. After 48 hours emergency module has to be put in emergency mode of operation (by fully disconnecting power supply of the L' line) Module should work in this mode until battery packs will be completely exhausted. Restoration of the power supply and charging the batteries for at least the next 36 hours is an end of the formatting cycle.

Tab.1.

TECHNICAL PARAMETERS	
Power supply	-230V ± 10% / 50Hz ± 2% for ST2 -230V ±10% / 50-60 Hz ± 2% for ST, PRO, COLD
Nominal power input	< 5W
Types of supported light sources	4 pin: T8, T5, TC-SEL; TC-DEL; TC-TEL; TC-F
Light source power	4W do 80W (by Tab.9)
Converter operating frequency	20÷35 kHz
Luminous flux	6÷42%
Open circuit voltage	1450V
Degree of protection	IP 20
Emergency switch time	0,2÷0,8 sec
Battery discharge current	0,5÷1,5A
Charging process length	24h (first charging 48h)
Battery packs are charged by direct current	
Temperature	Ta=10°÷ 50°C - VIP..ST/AT/PRO/DATA Ta=-15°÷ 50°C - VIP..COLD
Overall dimensions	ST: 1159 x w41 x H33 [mm] (polycarbonate) PRO/ST/ST2/COLD: 1179 x w38 x H33/H28 [mm] (polycarbonate) COLD: 1176 x w36 x H30,5 [mm] (metal)***
Maximum cord length	1,5m; ST: pin nr 3(S),7; PRO/ST2/COLD: pin nr 8,12

***option

Tab.2.

Type	Model	Power	Time	Battery
VIP ST	136	4-36W	1 h	3xSc
VIP ST	236	4-36W	2 h	3xC
VIP ST	336	4-36W	3 h	3xD
VIP ST	158	4-58W	1 h	4xSc
VIP ST	258	4-58W	2 h	4xC
VIP ST	358	4-58W	3 h	4xD

Tab.3.

Type	Model	Power	Time	Battery
VIP ST	136ie	4-36W	1 h	3xSc
VIP ST	236ie	4-36W	2 h	3xC
VIP ST	336ie	4-36W	3 h	3xD
VIP ST	158ie	4-58W	1 h	4xSc
VIP ST	258ie	4-58W	2 h	4xC
VIP ST	358ie	4-58W	3 h	4xD

Tab.4.

Type	Model	Power	Time	Battery
VIP ST2	136	4-36W	1 h	3xSc
VIP ST2	236	4-36W	2 h	3xC
VIP ST2	336	4-36W	3 h	3xD
VIP ST2	158	4-58W	1 h	4xSc
VIP ST2	258	4-58W	2 h	4xC
VIP ST2	358	4-58W	3 h	4xD

Tab.5.

Type	Model	Power	Time	Battery
VIP PRO	180i	4-80W	1 h	5xC
VIP PRO	380i	4-80W	3 h	5xD

Tab.6.

Type	Model	Power	Time	Battery
VIP PRO	158i AT	4-58W	1 h	4xSc
VIP PRO	358i AT	4-58W	3 h	4xD
VIP PRO	180i AT	4-80W	1 h	5xC
VIP PRO	380i AT	4-80W	3 h	5xD

Tab.7.

Type	Model	Power	Time	Battery
VIP PRO	158i DATA	4-58W	1 h	4xSc
VIP PRO	358i DATA	4-58W	3 h	4xD
VIP PRO	180i DATA	4-80W	1 h	5xC
VIP PRO	380i DATA	4-80W	3 h	5xD

Tab.8.

Type	Model	Power	Time	Battery
VIP COLD	136Li	4-36W	1 h	6,4 V/3,0 Ah
VIP COLD	236Li	4-36W	2 h	6,4 V/4,5 Ah
VIP COLD	336Li	4-36W	3 h	6,4 V/6,0 Ah
VIP COLD	236Li AT	4-36W	2 h	6,4 V/4,5 Ah
VIP COLD	336Li AT	4-36W	3 h	6,4 V/6,0 Ah
VIP COLD	336Li DATA	4-36W	3 h	6,4 V/6,0 Ah
VIP COLD	158Li	4-58W	1 h	6,4 V/3,0 Ah
VIP COLD	258Li	4-58W	2 h	6,4 V/4,5 Ah
VIP COLD	358Li	4-58W	3 h	6,4 V/6,0 Ah
VIP COLD	158Li AT	4-58W	1 h	6,4 V/3,0 Ah
VIP COLD	258Li AT	4-58W	2 h	6,4 V/4,5 Ah
VIP COLD	358Li AT	4-58W	3 h	6,4 V/6,0 Ah
VIP COLD	358Li DATA	4-58W	3 h	6,4 V/6,0 Ah

BATTERY LIFESPAN CURVES

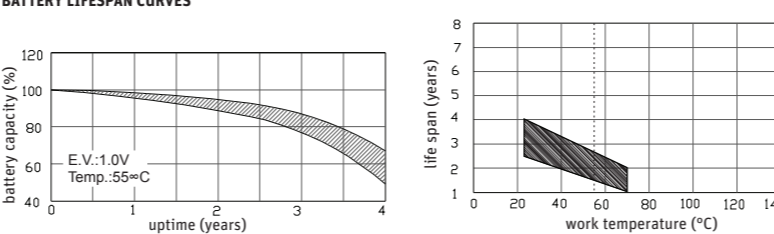

Tab.9. Table of light stream values of fluorescent light sources supplied by emergency lighting modules VIP ST, VIP ST2, VIP PRO (AT, CT, DATA, COLD) (BLF) in %.

Type of fluorescent lamp (shaft)	Power of fluorescent lamp	VIP ST x36 VIP ST x36ie VIP ST2 x36	VIP ST x58 VIP ST x58ie VIP ST2 x58 VIP PRO x58i (AT, DATA)	VIP PRO x80i (AT, CT, DATA) VIP PRO c80i COLD (AT, DATA)
T8 (G13)	18W	9,00%	10,00%	19,00%****
	30W	9,00%	10,00%	16,00%****
	36W	8,00%	9,00%	14,00%****
	58W	-	6,00%	8,00%****
	70W	-	-	7,00%
	80W	-	-	6,00%
T5 (G5)	4W	28,00%	32,00%	42,00%
	6W	23,00%	26,00%	38,00%
	8W	21,00%	22,00%	33,00%
	13W	18,00%	19,00%	28,00%
	14W	17,00%	18,00%	25,00%
	21W	-	15,00%	21,00%
	24W	-	12,00%	20,00%
	28W	-	-	15,00%
	35W	-	-	10,00%
	39W	-	-	10,00%
	49W	-	-	8,00%
	54W	-	-	6,00%
	80W	-	-	6,00%
PL-S (2G7)	5W	26,00%	27,00%	38,00%
	7W	22,00%	22,00%	33,00%
	9W	19,00%	19,00%	28,00%
	11W	21,00%	21,00%	30,00%
	18W	10,00%	11,00%	15,00%
PL-L (2G11)	24W	12,00%	11,00%	16,00%
	36W	8,00%	9,00%	12,00%
	40W	-	7,00%	9,00%
	55W	-	-	9,00%
	16W	14,00%	15,00%	24,00%
PL-Q (GR10Q)	28W	-	10,00%	12,00%
	38W	-	7,00%	8,00%
	10W	17,00%	18,00%	26,00%
	13W	16,00%	17,00%	24,00%
	18W	14,00%	16,00%	19,00%
PL-C (G24Q)	26W	10,00%	13,00%	15,00%
	13W	17,00%	18,00%	22,00%
	18W	15,00%	16,00%	20,00%
	26W	-	13,00%	15,00%
	32W	-	9,00%	13,00%
PL-T (G24Q)	42W	-	-	8,00%
	57W	-	-	6,00%

x- duration time 1h or 3h
 ****for COLD version

CIRCUIT DIAGRAMS

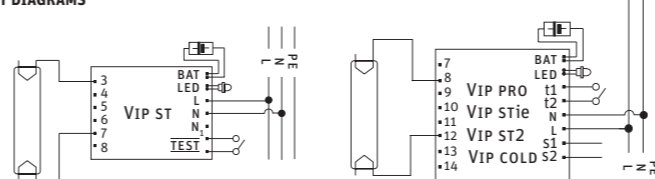

Fig. 1 Emergency mode with one fluorescent lamp (VIP ST, VIP PRO/VIP STie/VIP ST2/VIP COLD)

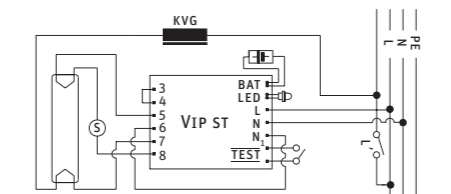

Fig.2. Supply-network and emergency mode with one fluorescent lamp (VIP ST)

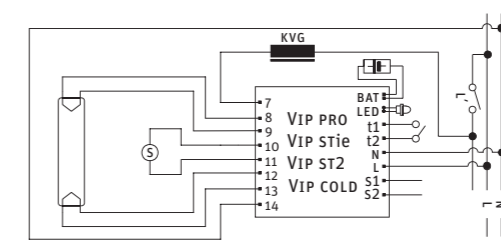

Fig.3. Supply network and emergency mode with one fluorescent lamp (VIP PRO/VIP STie/VIP ST2/VIP COLD)

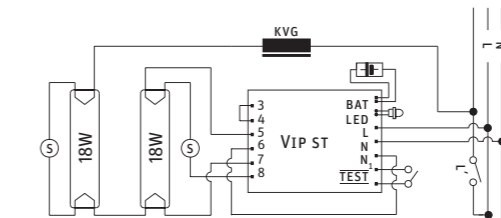

Fig.4. Supply-network and emergency mode with two fluorescent lamps 18 W (VIP ST)
 Emergency mode with one fluorescent lamp.

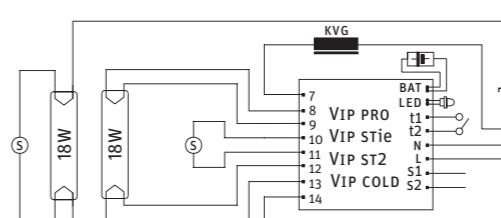

Fig.5. Supply-network and post current-decay mode with two fluorescent lamps 18 W (VIP PRO/VIP STie/VIP ST2/VIP COLD). Emergency mode with one fluorescent lamp.

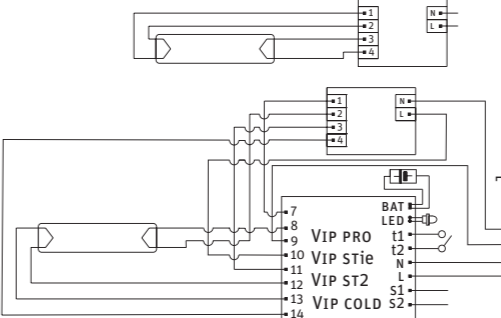

Fig.6. Supply-network and emergency mode with one fluorescent lamp in electronic ballast circuit (VIP PRO/VIP STie/VIP ST2/VIP COLD)

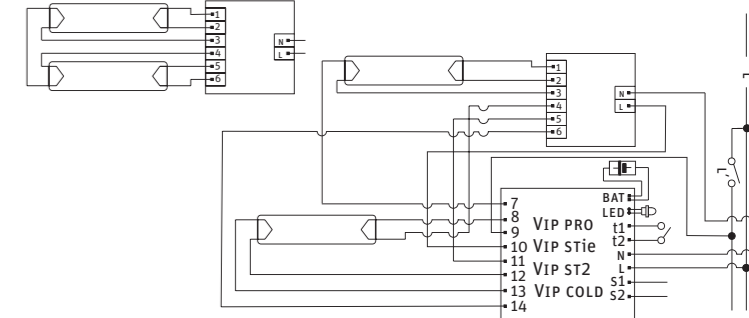

Fig.7. Supply-network and post-current decay mode with two fluorescent lamp in electronic ballast circuit (VIP PRO/VIP STie/VIP ST2/VIP COLD). Emergency mode with one fluorescent lamp.

Circuit drawings of modules connected to other types of electronic ballast are posted on website: www.tmtechnologie.pl/connection-schemes.html

EMERGENCY MODE CONTROL

Electric light fitting with emergency lighting module VIP has to be periodically tested in accordance with applicable regulations (norm PN-EN 50172) Test reports are available for inspection.

Version	Testing correct operation of the fitting
ST	Everyday – checking if the diode in the fitting lights up. In the correct battery charging the LED diode glows continuously. Once a month – turn off the power supply or push the button activating test mode. The light source should light up and the LED diode should turn off. Once a year – turn off its power supply and measure the duration. Check if the duration is not less than the nominal time.
AT	The module automatically conveys two test types: Formatting test is performed after 48 hours from the start the device. Test A functional is performed every 30 days. Functional test continues: for modules 3 h – 60 seconds, for modules 1h, 2 h – 30 seconds. Test B of duration (corresponding to the nominal operation time) performed regularly every 90 days. Attention! Test A will be shifted forward by 5h if power failure take place in the last 4h before this test. Test B will be shifted forward by 48h if power failure take place in the last 24h before this test. Tests can be done manually by using the test button: Test A – press the button for no more than 4 seconds. Test B – pressing the min. 5 seconds (test can be done after 48 hours of first use of the device). LED indication: Information for the nominal operation time. After the start, the LED light goes out at 2 times per second: 1 time for 1 hour module, 2 times for 2 hours, 3 times for 3 hours. During operation, the LED indicator lights continuously (for devices with LiFePO4 battery after charging LED goes out once every 15 seconds, during the test the LED light flashes at a frequency of 1 per second). Errors are indicated by the blinking LED at a frequency of 5 times per second.
DATA	Everyday – battery charging should be tested: by controlling fitting parameters or by checking if the LED diode in the fitting lights up: continuous light – the fitting operates correctly, pulsating light – lack of the battery or the battery is damaged, no light – no power supply in the fitting. Once a month – with the use of operational central panel: Test A (5 min.) – after the test refresh fitting parameters and control their correctness. Once a year – test should be performed in nominal operation time, after the test refresh fitting parameters and control their correctness. In the fittings with LiFePO4 battery, green light turns off, the red light operate in cycle 14 to 1 (14s LED is on, 1s LED is off) when the battery pack is fully charged.
CB	System of central battery should carry out all tests ordered by regulations.